

Chapter 7

Wireless and Mobile Networks

A note on the use of these Powerpoint slides:

We're making these slides freely available to all (faculty, students, readers). They're in PowerPoint form so you see the animations; and can add, modify, and delete slides (including this one) and slide content to suit your needs. They obviously represent a *lot* of work on our part. In return for use, we only ask the following:

- If you use these slides (e.g., in a class) that you mention their source (after all, we'd like people to use our book!)
- If you post any slides on a www site, that you note that they are adapted from (or perhaps identical to) our slides, and note our copyright of this material.

Thanks and enjoy! JFK/KWR

© All material copyright 1996-2016
© J.F Kurose and K.W. Ross, All Rights Reserved

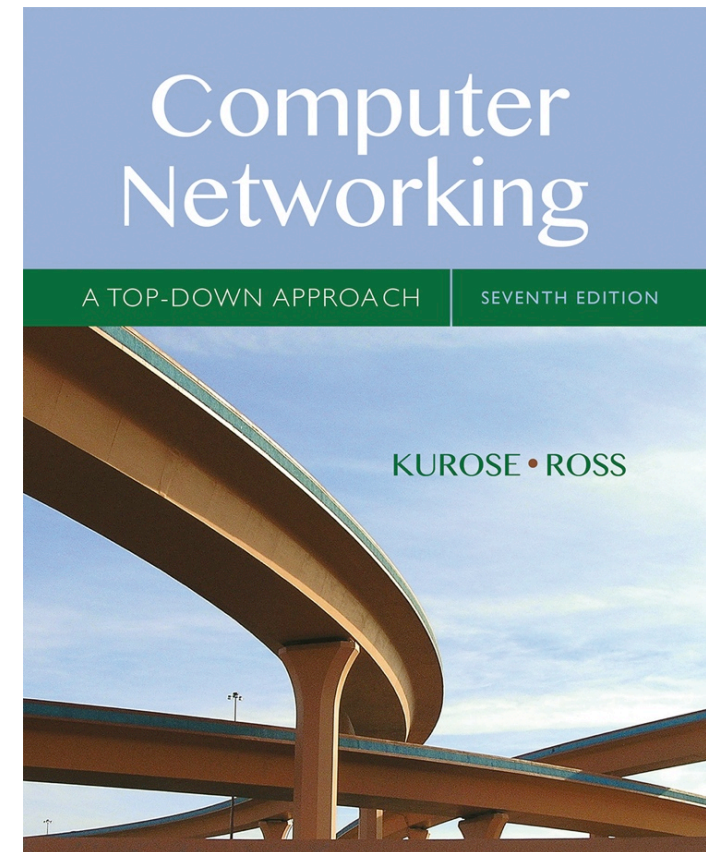

Computer Networking: A Top Down Approach

7th edition

Jim Kurose, Keith Ross

Pearson/Addison Wesley

April 2016

Ch. 6: Wireless and Mobile Networks

Background:

- # wireless (mobile) phone subscribers now exceeds # wired phone subscribers (5-to-1)!
- # wireless Internet-connected devices equals # wireline Internet-connected devices
 - laptops, Internet-enabled phones promise anytime untethered Internet access
- two important (but different) challenges
 - *wireless*: communication over wireless link
 - *mobility*: handling the mobile user who changes point of attachment to network

Chapter 7 outline

7.1 Introduction

Wireless

7.2 Wireless links, characteristics

- CDMA

7.3 IEEE 802.11 wireless LANs (“Wi-Fi”)

Elements of a wireless network

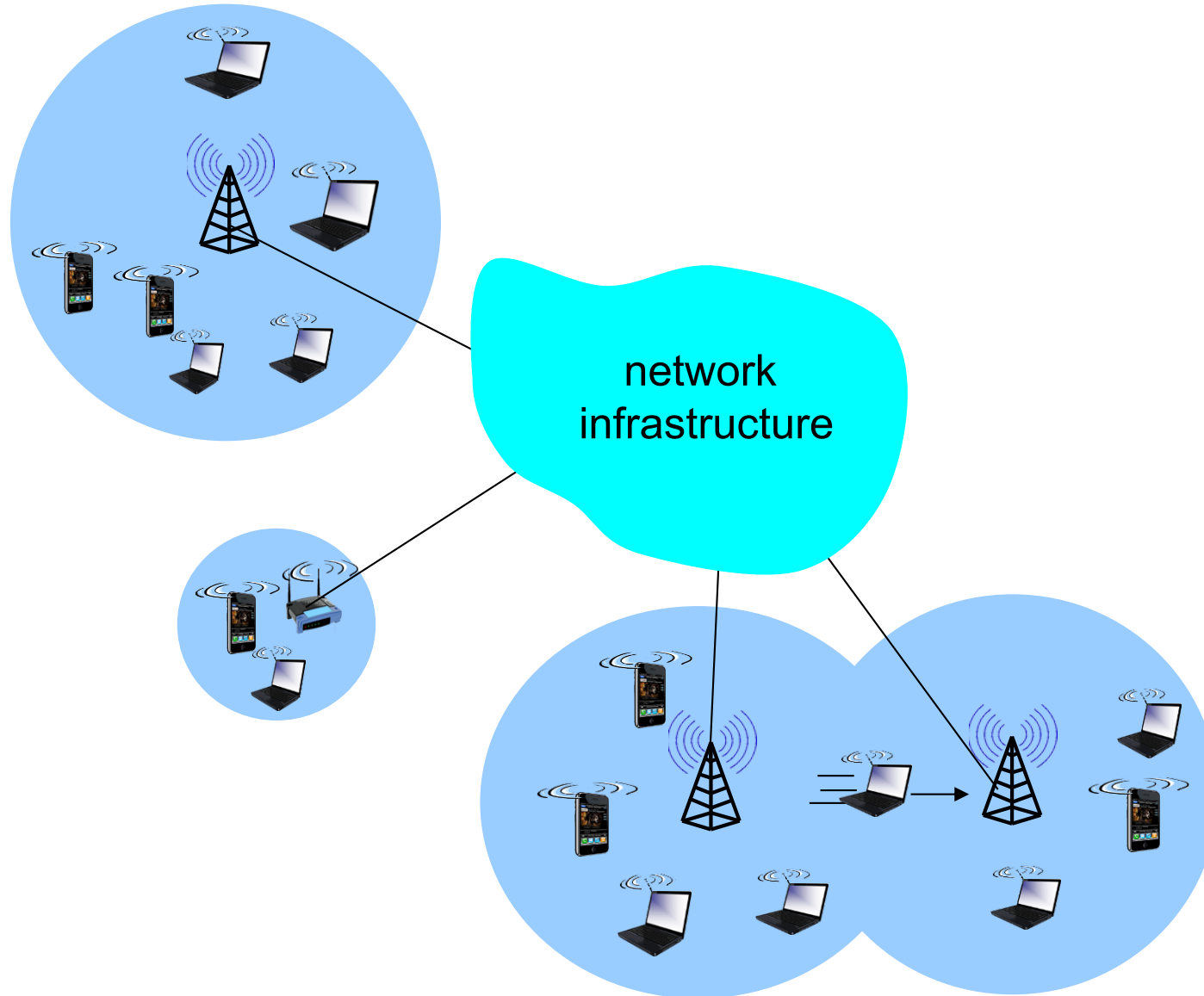

Elements of a wireless network

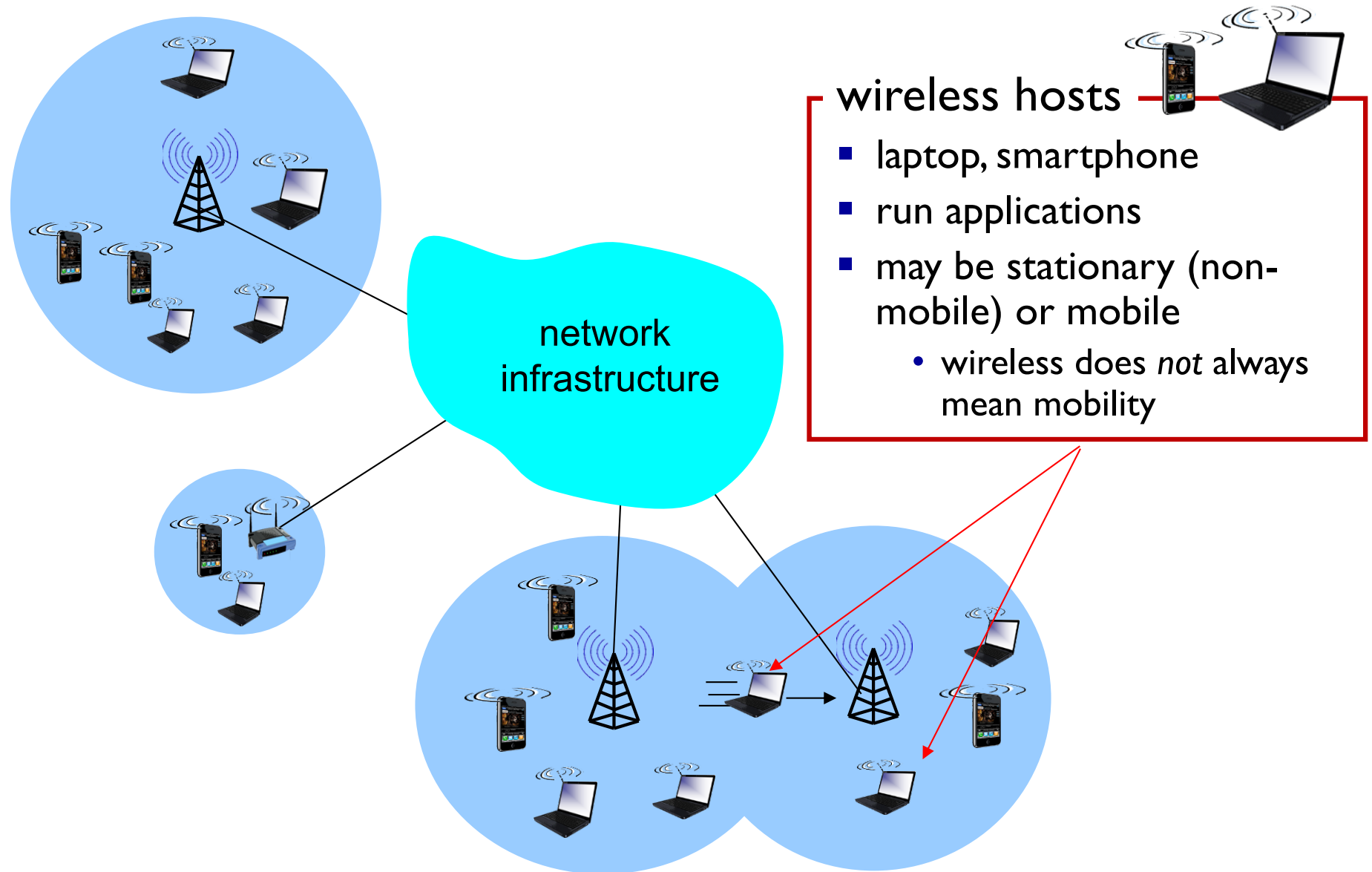

Elements of a wireless network

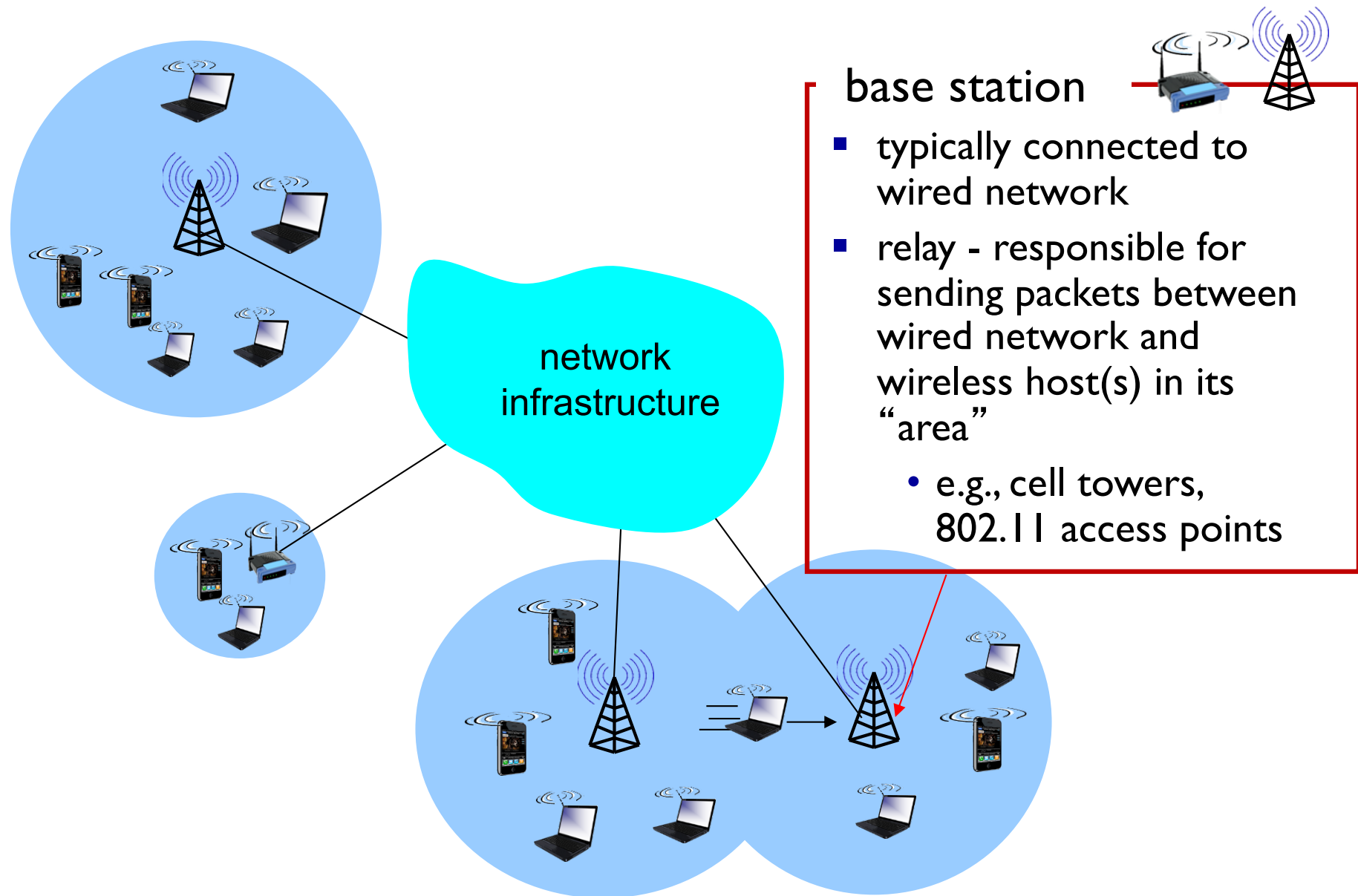

Elements of a wireless network

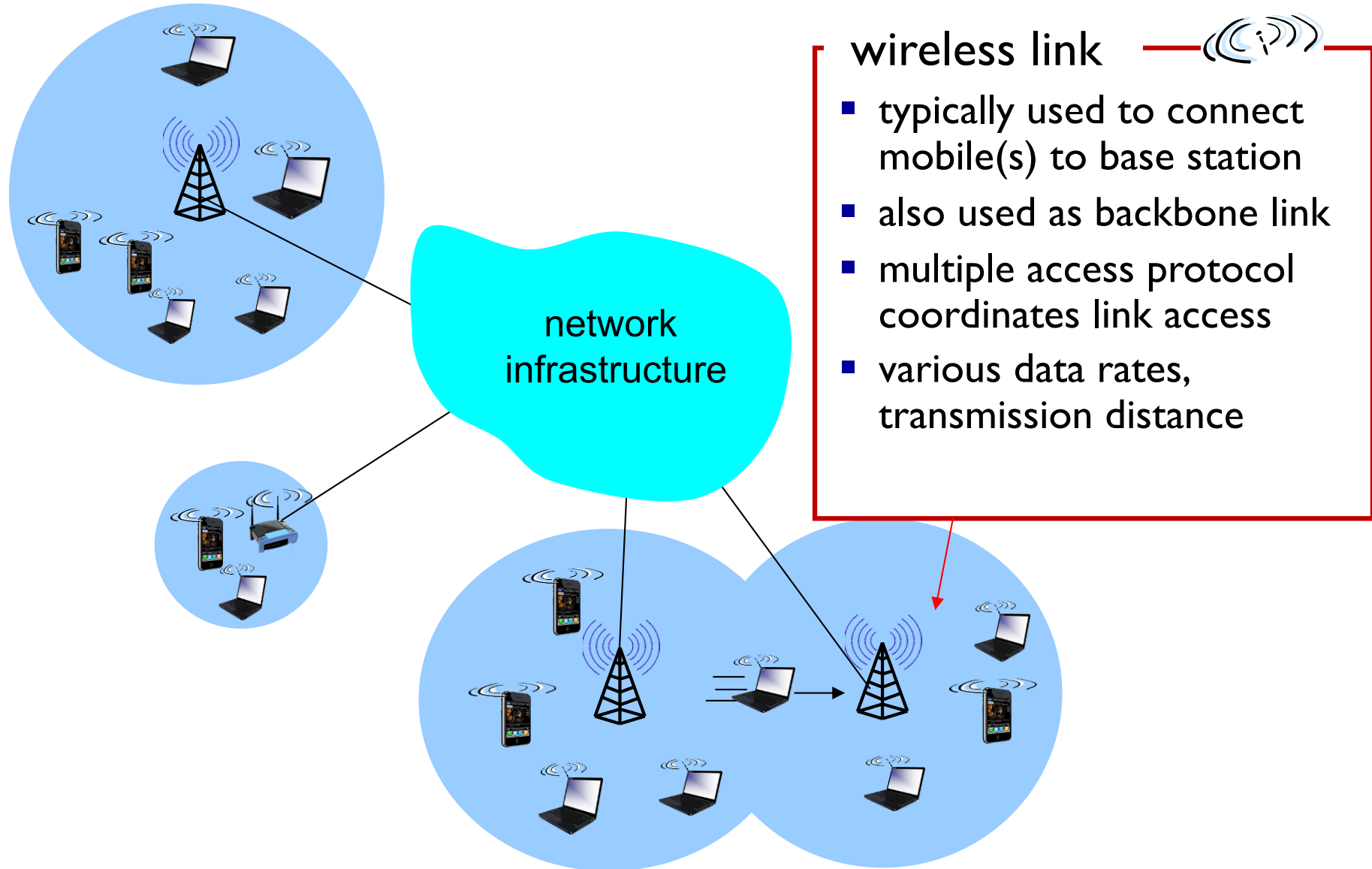

Characteristics of selected wireless links

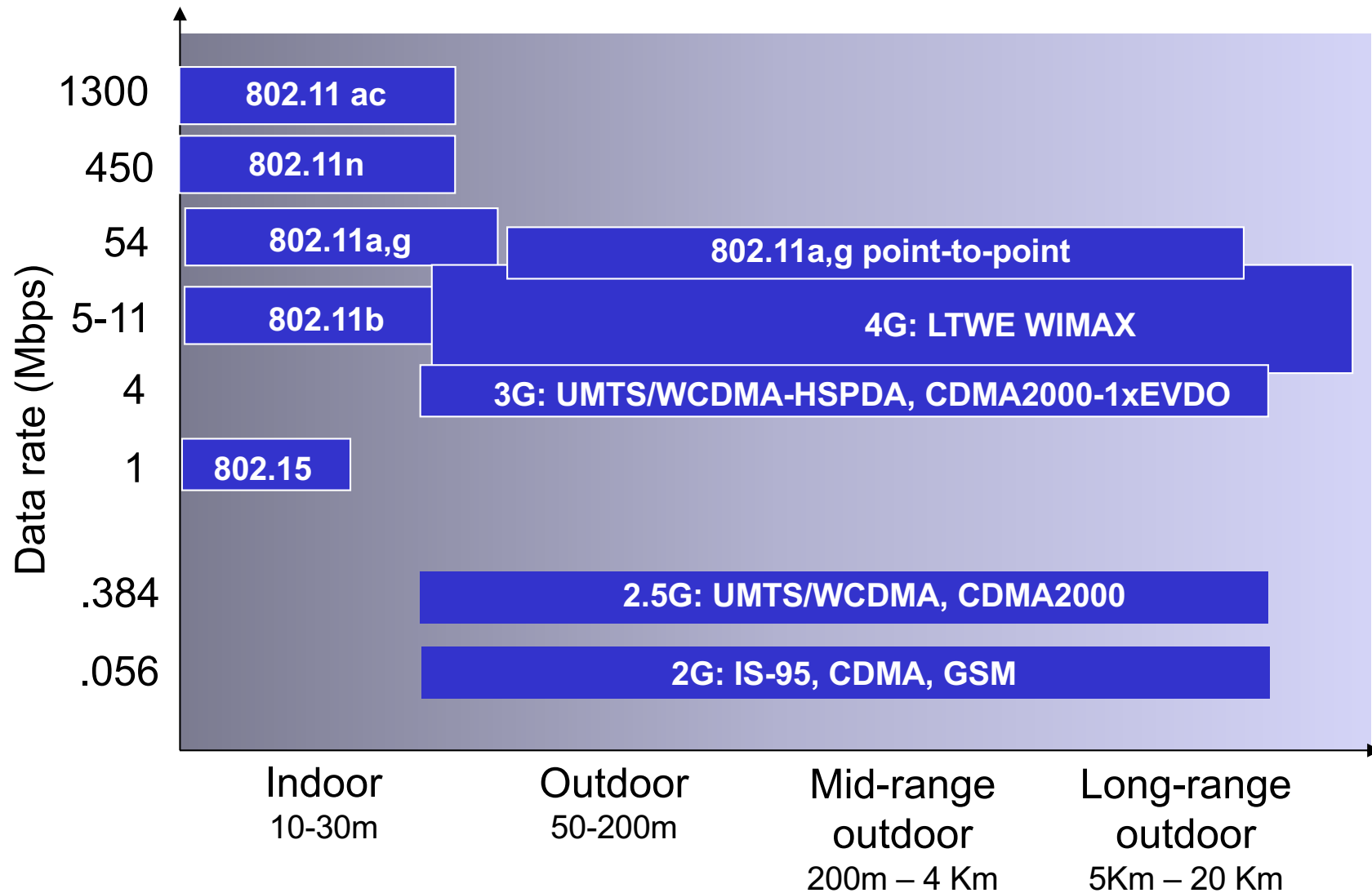

Elements of a wireless network

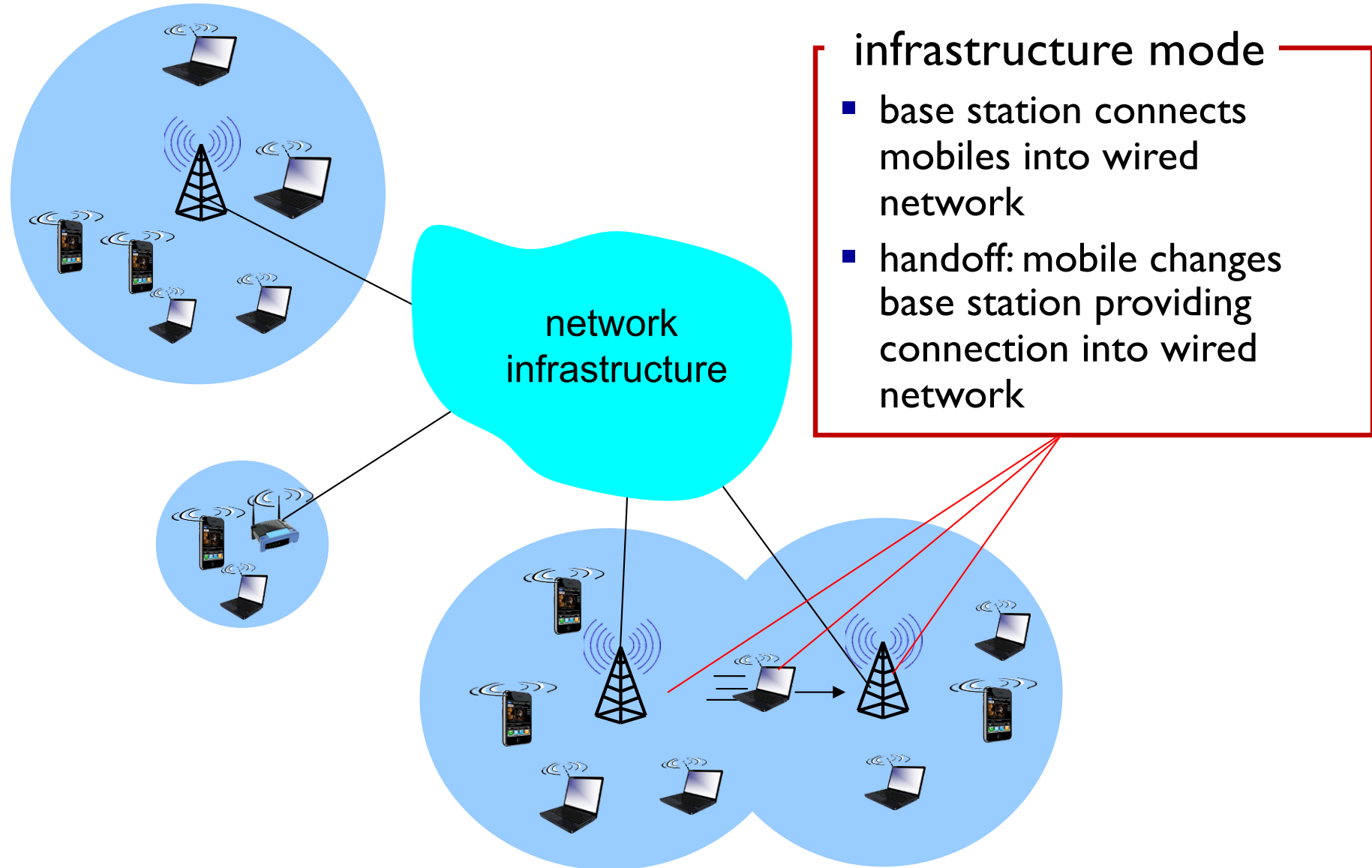

Elements of a wireless network

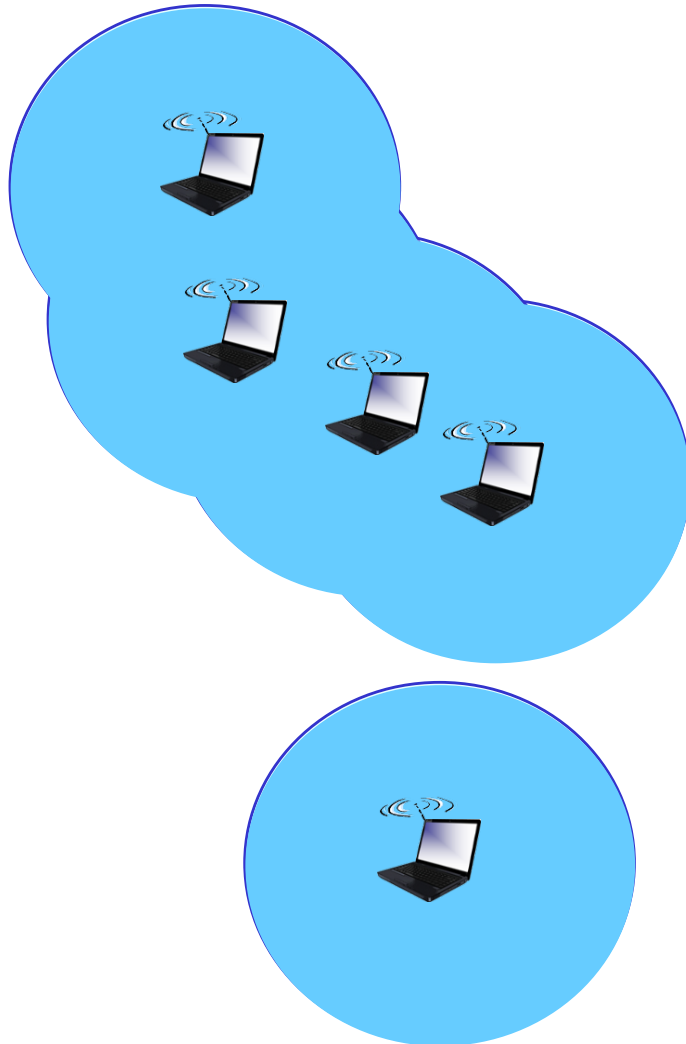

ad hoc mode

- no base stations
- nodes can only transmit to other nodes within link coverage
- nodes organize themselves into a network: route among themselves

Wireless network taxonomy

	single hop	multiple hops
infrastructure (e.g., APs)	host connects to base station (WiFi, WiMAX, cellular) which connects to larger Internet	host may have to relay through several wireless nodes to connect to larger Internet: <i>mesh net</i>
no infrastructure	no base station, no connection to larger Internet (Bluetooth, ad hoc nets)	no base station, no connection to larger Internet. May have to relay to reach other a given wireless node MANET, VANET

Chapter 7 outline

7.1 Introduction

Wireless

7.2 Wireless links, characteristics

- CDMA

7.3 IEEE 802.11 wireless LANs (“Wi-Fi”)

Wireless Link Characteristics (I)

important differences from wired link

- *decreased signal strength*: radio signal attenuates as it propagates through matter (path loss)
- *interference from other sources*: standardized wireless network frequencies (e.g., 2.4 GHz) shared by other devices (e.g., phone); devices (motors) interfere as well
- *multipath propagation*: radio signal reflects off objects ground, arriving at destination at slightly different times

.... make communication across (even a point to point) wireless link much more “difficult”

Wireless Link Characteristics (2)

- SNR: signal-to-noise ratio
 - larger SNR – easier to extract signal from noise (a “good thing”)
- *SNR versus BER tradeoffs*
 - *given physical layer*: increase power \rightarrow increase SNR \rightarrow decrease BER
 - *given SNR*: choose physical layer that meets BER requirement, giving highest throughput
 - SNR may change with mobility: dynamically adapt physical layer (modulation technique, rate)

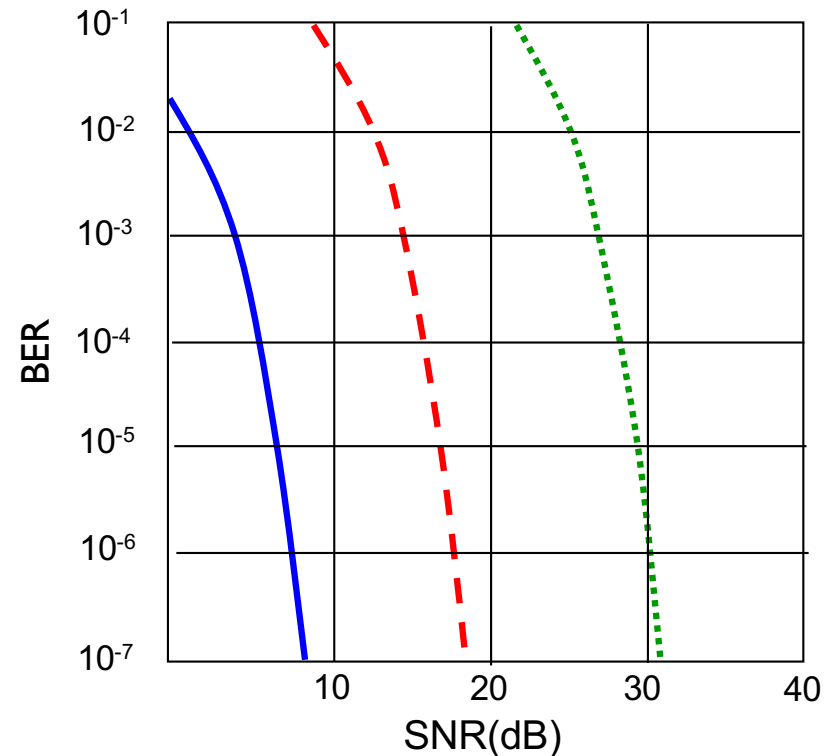

- QAM256 (8 Mbps)
- - - QAM16 (4 Mbps)
- BPSK (1 Mbps)

Wireless network characteristics

Multiple wireless senders and receivers create additional problems (beyond multiple access):

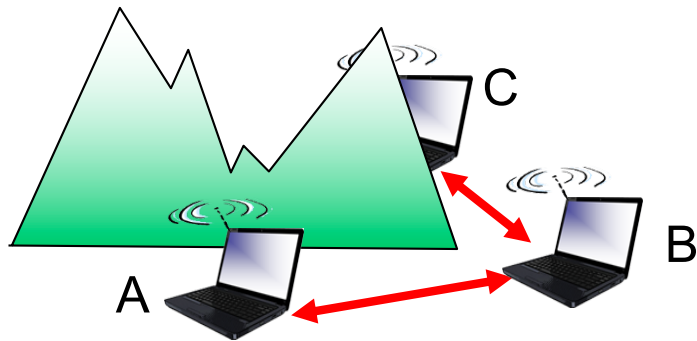

Hidden terminal problem

- B, A hear each other
- B, C hear each other
- A, C can not hear each other means A, C unaware of their interference at B

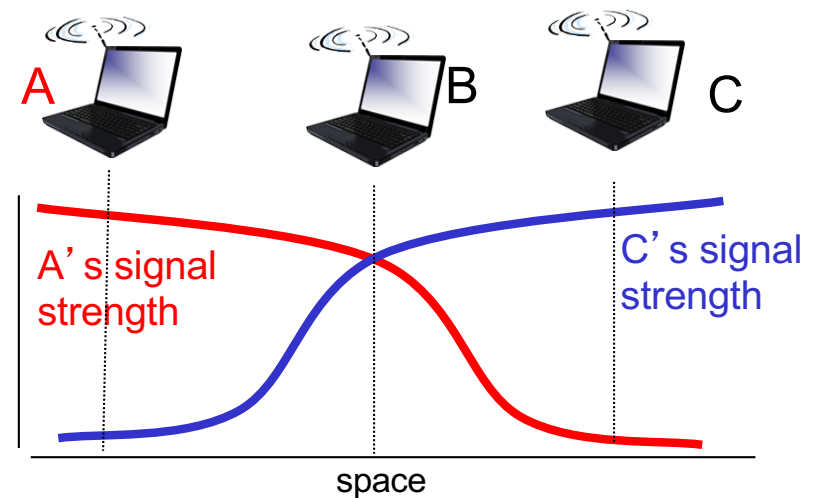

Signal attenuation:

- B, A hear each other
- B, C hear each other
- A, C can not hear each other interfering at B

Code Division Multiple Access (CDMA)

- unique “code” assigned to each user; i.e., code set partitioning
 - all users share same frequency, but each user has own “chipping” sequence (i.e., code) to encode data
 - allows multiple users to “coexist” and transmit simultaneously with minimal interference (if codes are “orthogonal”)
- *encoded signal* = (original data) X (chipping sequence)
- *decoding*: inner-product of encoded signal and chipping sequence

CDMA encode/decode

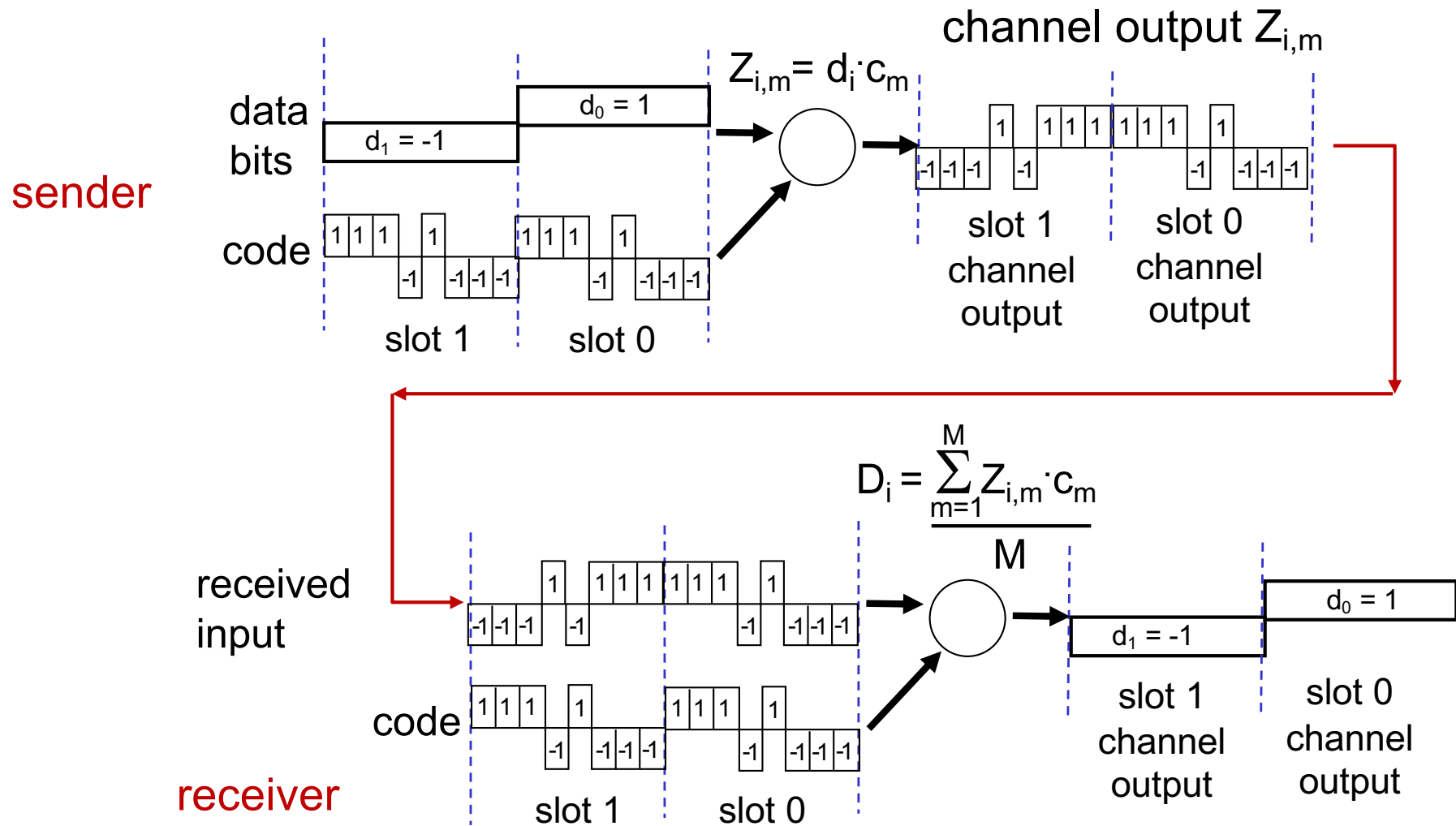

CDMA: two-sender interference

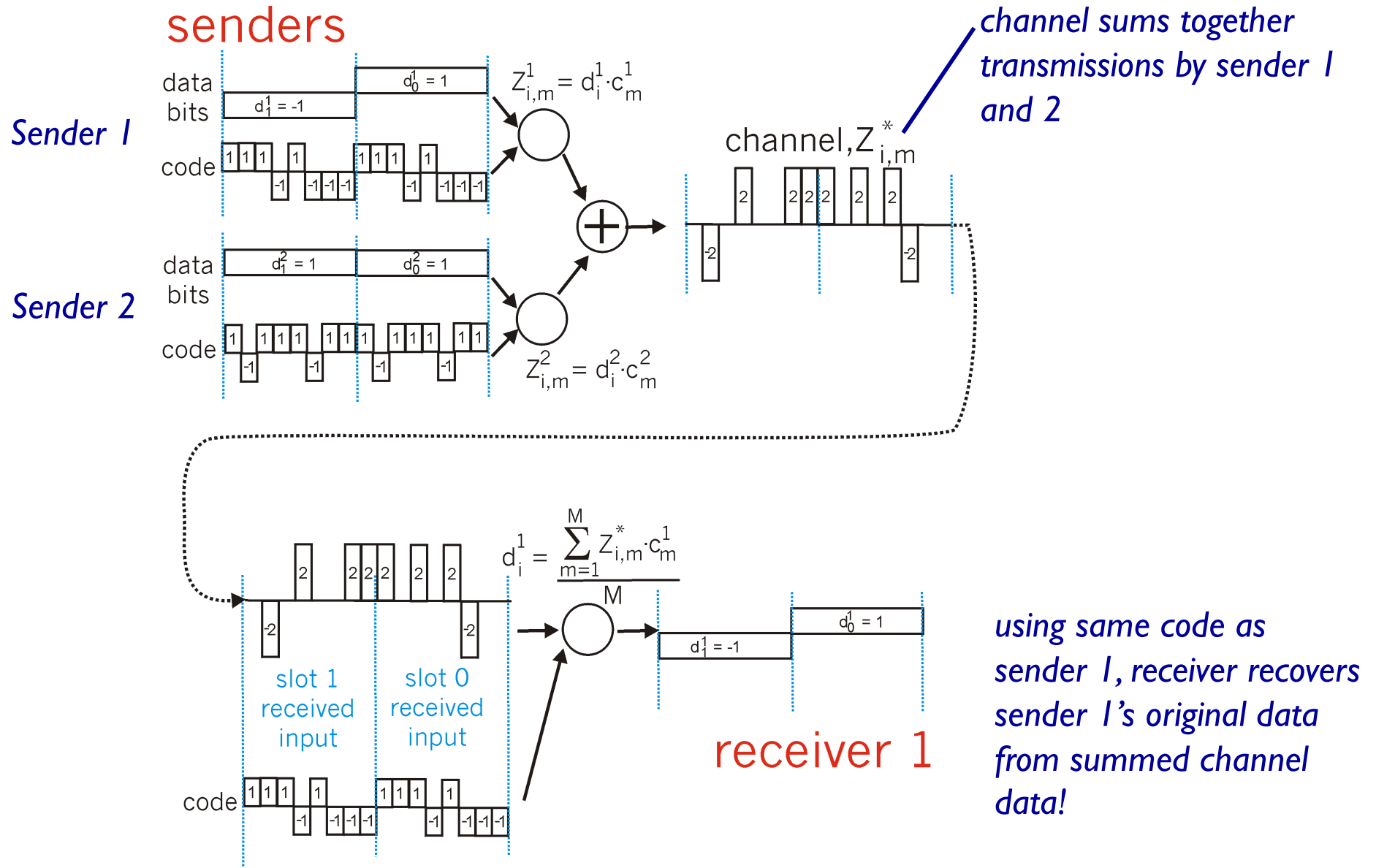

Chapter 7 outline

7.1 Introduction

Wireless

7.2 Wireless links, characteristics

- CDMA

7.3 IEEE 802.11 wireless LANs (“Wi-Fi”)

IEEE 802.11 Wireless LAN

802.11b

- 2.4-5 GHz unlicensed spectrum
- up to 11 Mbps
- direct sequence spread spectrum (DSSS) in physical layer
 - all hosts use same chipping code

802.11a

- 5-6 GHz range
- up to 54 Mbps

802.11g

- 2.4-5 GHz range
- up to 54 Mbps

802.11n: multiple antennae

- 2.4-5 GHz range
- up to 200 Mbps

-
- all use CSMA/CA for multiple access
 - all have base-station and ad-hoc network versions

802.11 LAN architecture

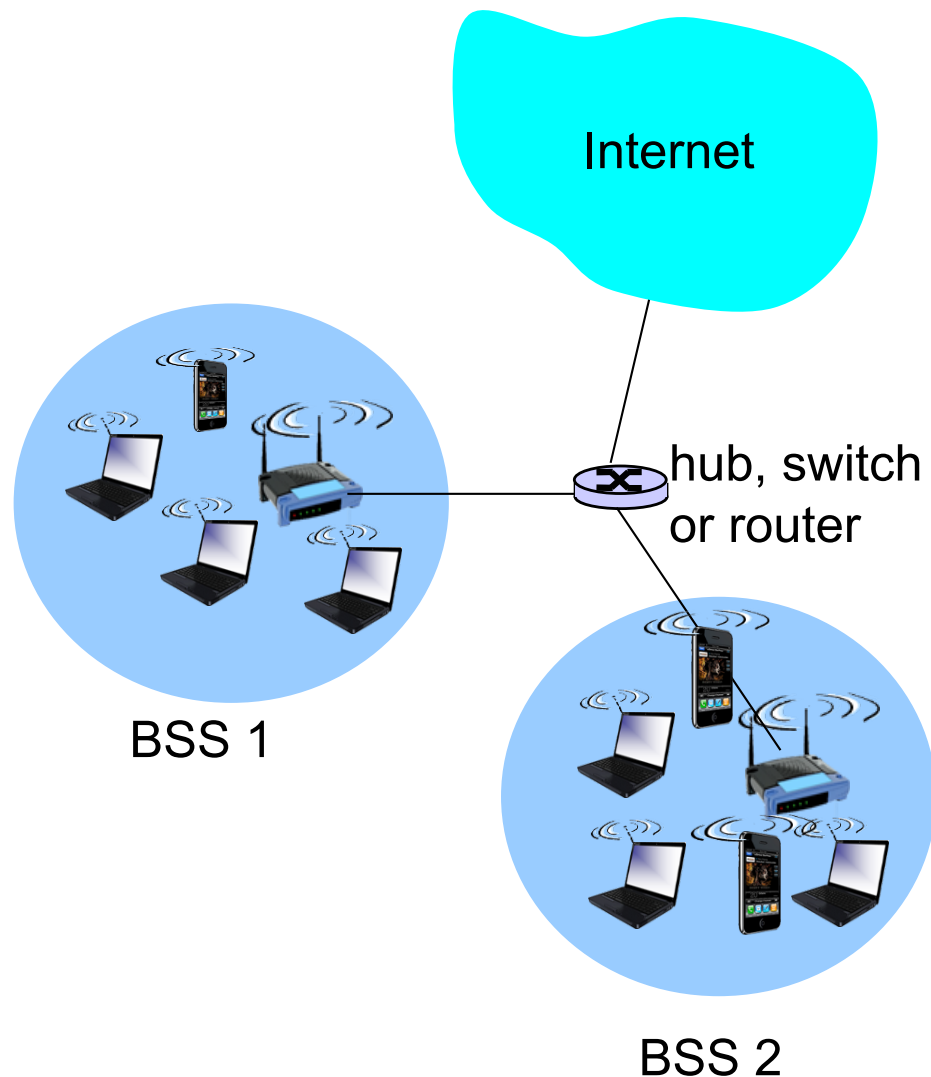

- wireless host communicates with base station
 - base station = access point (AP)
- Basic Service Set (BSS) (aka “cell”) in infrastructure mode contains:
 - wireless hosts
 - access point (AP): base station
 - ad hoc mode: hosts only

802.11: Channels, association

- 802.11b: 2.4GHz-2.485GHz spectrum divided into 11 channels at different frequencies
 - AP admin chooses frequency for AP
 - interference possible: channel can be same as that chosen by neighboring AP!
- host: must *associate* with an AP
 - scans channels, listening for *beacon frames* containing AP's name (SSID) and MAC address
 - selects AP to associate with
 - may perform authentication [Chapter 8]
 - will typically run DHCP to get IP address in AP's subnet

802.11: passive/active scanning

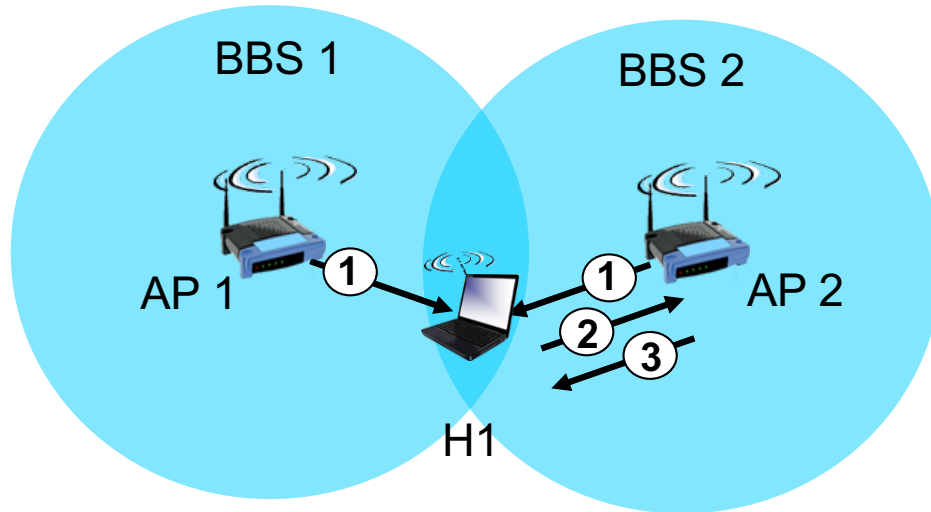

passive scanning:

- (1) beacon frames sent from APs
- (2) association Request frame sent: H1 to selected AP
- (3) association Response frame sent from selected AP to H1

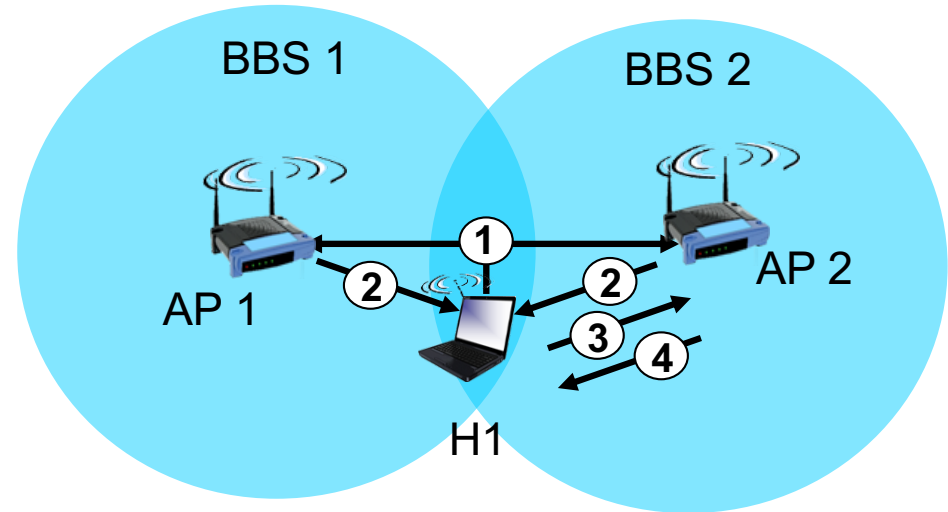

active scanning:

- (1) Probe Request frame broadcast from H1
- (2) Probe Response frames sent from APs
- (3) Association Request frame sent: H1 to selected AP
- (4) Association Response frame sent from selected AP to H1

IEEE 802.11: multiple access

- avoid collisions: 2+ nodes transmitting at same time
- 802.11: CSMA - sense before transmitting
 - don't collide with ongoing transmission by other node
- 802.11: *no* collision detection!
 - difficult to receive (sense collisions) when transmitting due to weak received signals (fading)
 - can't sense all collisions in any case: hidden terminal, fading
 - goal: *avoid collisions*: CSMA/C(ollision)A(avoidance)

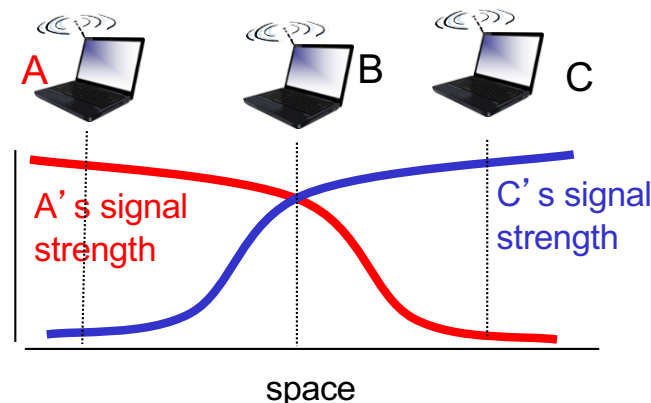
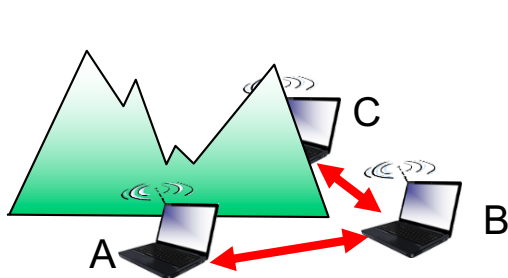

IEEE 802.11 MAC Protocol: CSMA/CA

802.11 sender

- 1 if sense channel idle for **DIFS** then
transmit entire frame (no CD)
- 2 if sense channel busy then
start random backoff time
timer counts down while channel idle
transmit when timer expires
if no ACK, increase random backoff interval,
repeat 2

802.11 receiver

- if frame received OK
return ACK after **SIFS** (ACK needed due to
hidden terminal problem)

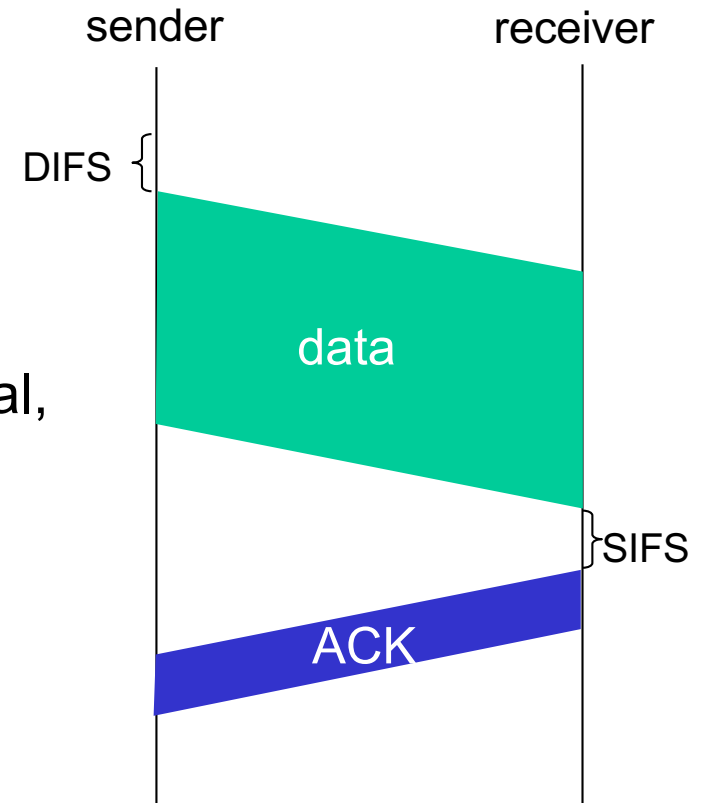

Avoiding collisions (more)

idea: allow sender to “reserve” channel rather than random access of data frames: avoid collisions of long data frames

- sender first transmits *small* request-to-send (RTS) packets to BS using CSMA
 - RTSs may still collide with each other (but they’re short)
- BS broadcasts clear-to-send CTS in response to RTS
- CTS heard by all nodes
 - sender transmits data frame
 - other stations defer transmissions

*avoid data frame collisions completely
using small reservation packets!*

Collision Avoidance: RTS-CTS exchange

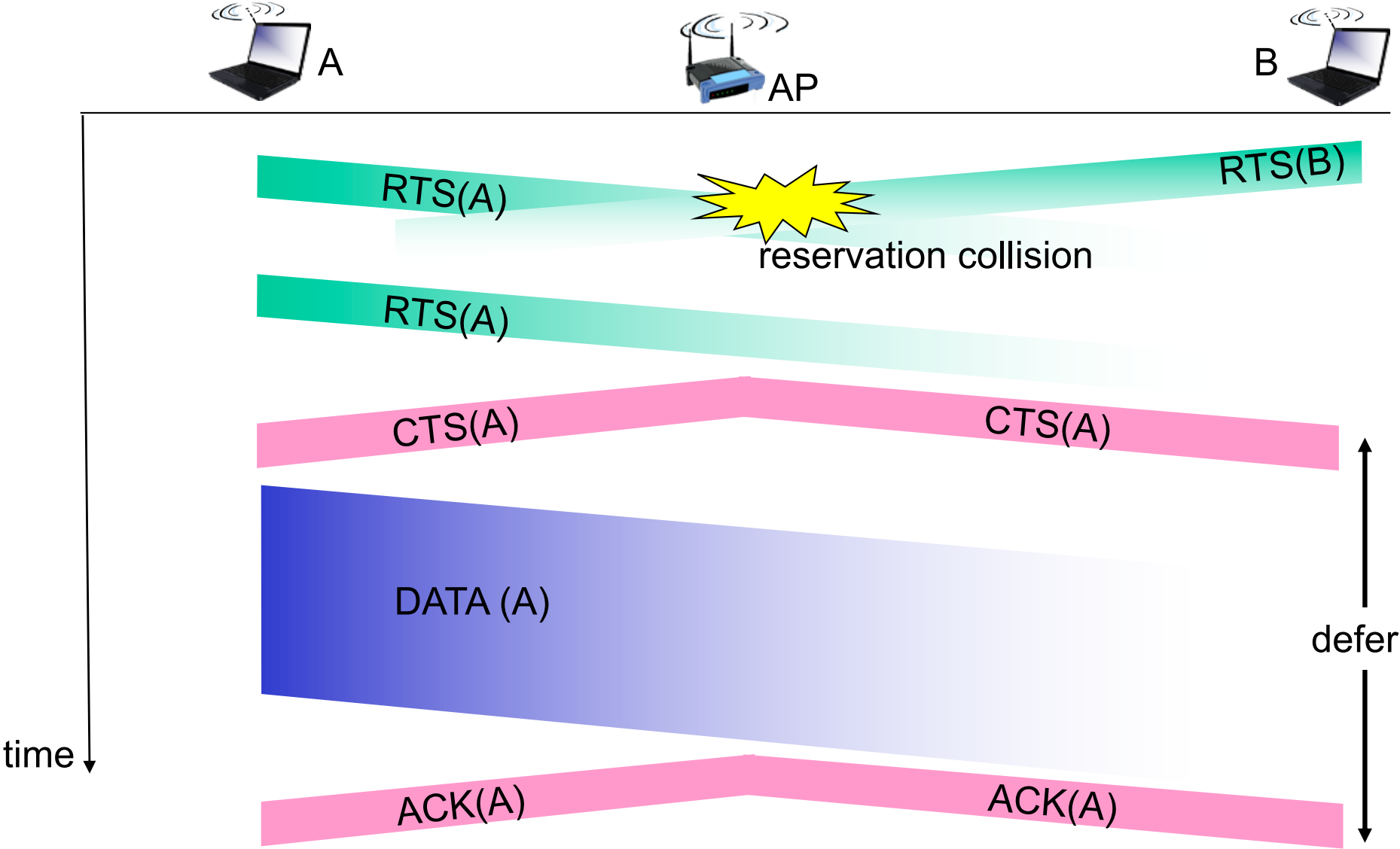

802.11 frame: addressing

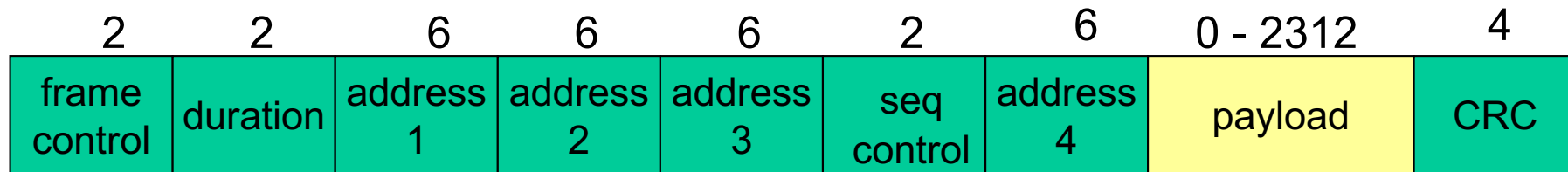

Address 1: MAC address of wireless host or AP to receive this frame

Address 2: MAC address of wireless host or AP transmitting this frame

Address 3: MAC address of router interface to which AP is attached

Address 4: used only in ad hoc mode

802.11 frame: addressing

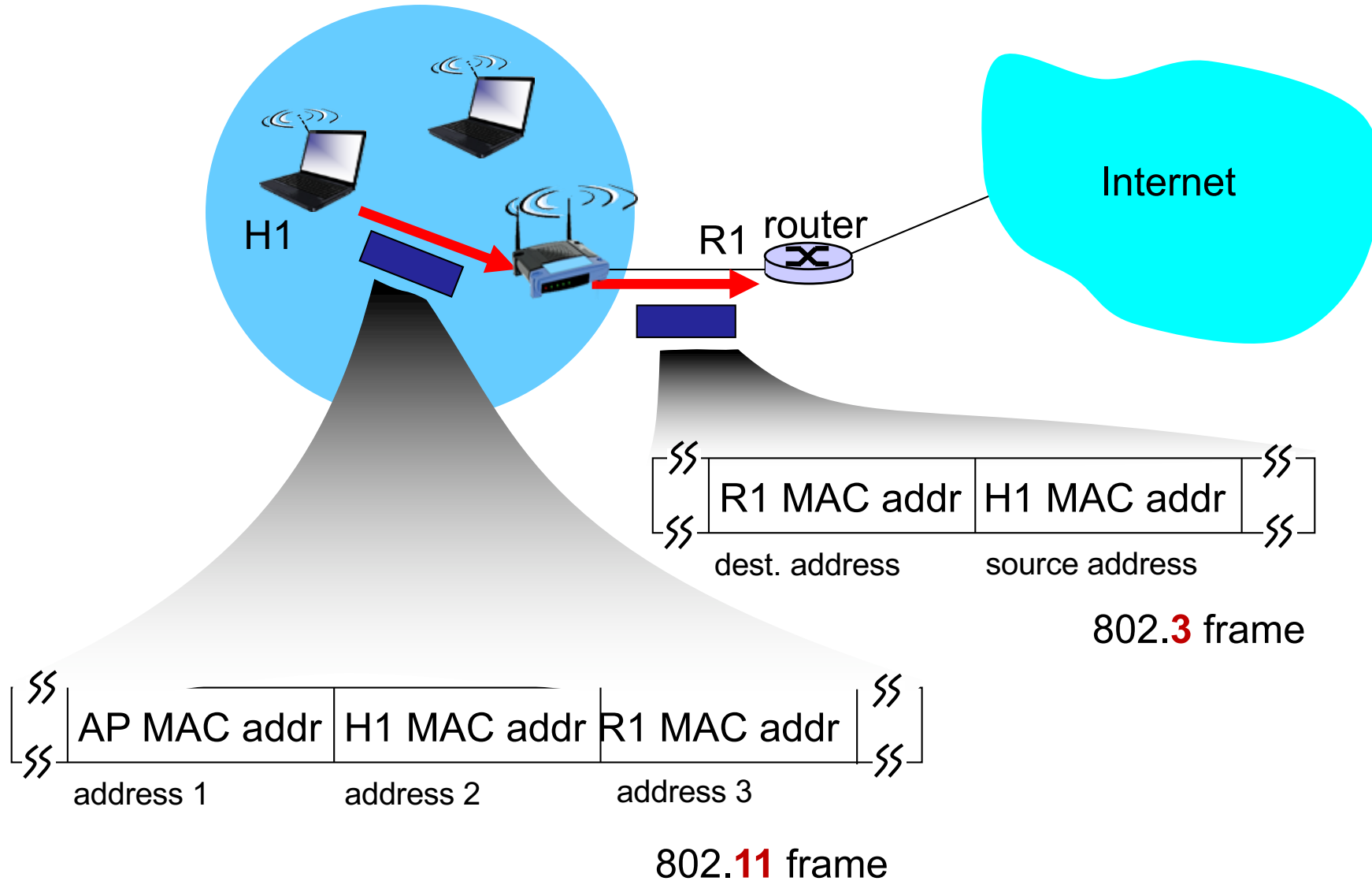

802.11 frame: more

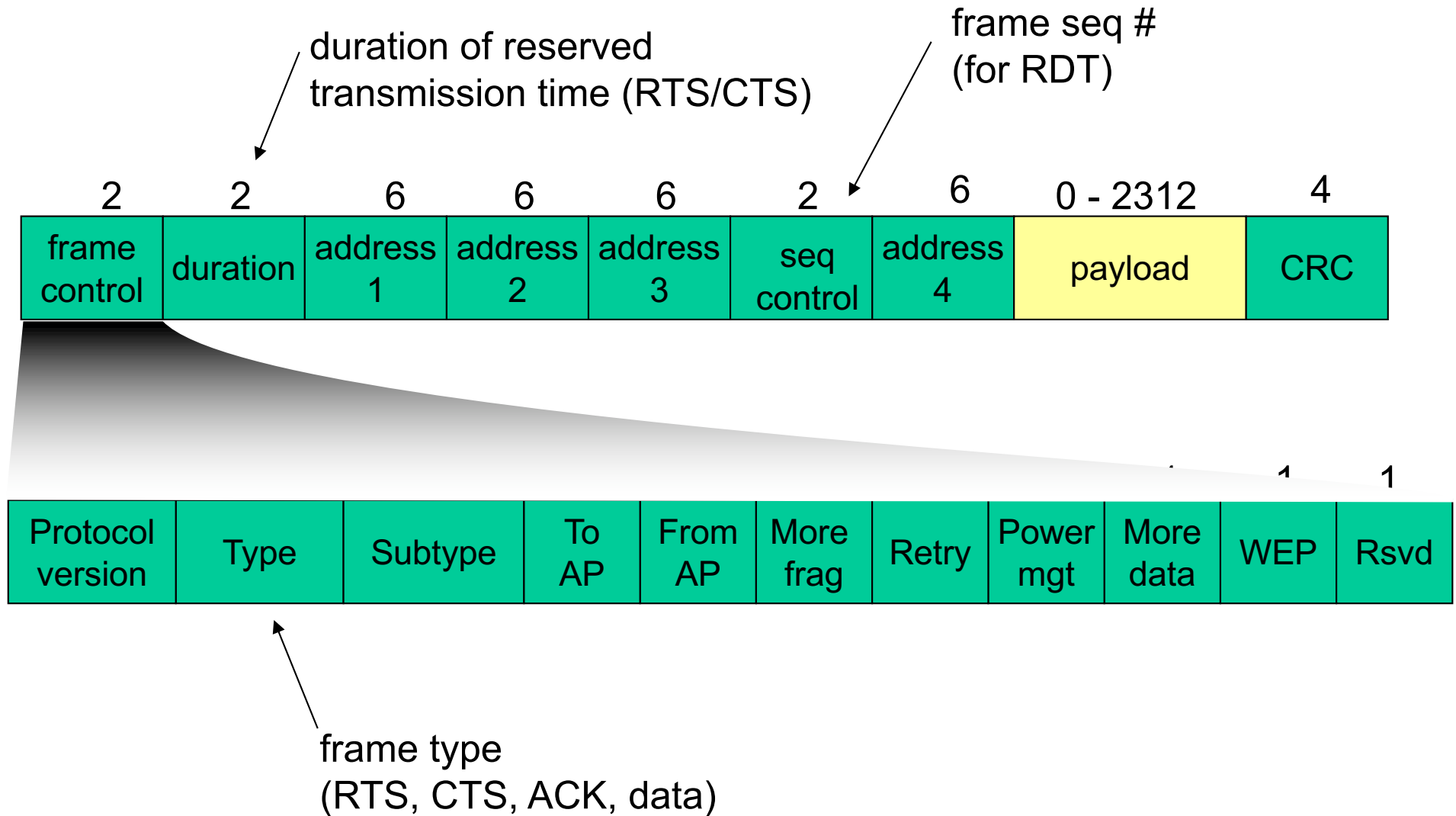

802.11: mobility within same subnet

- HI remains in same IP subnet: IP address can remain same
- switch: which AP is associated with HI?
 - self-learning (Ch. 5): switch will see frame from HI and “remember” which switch port can be used to reach HI

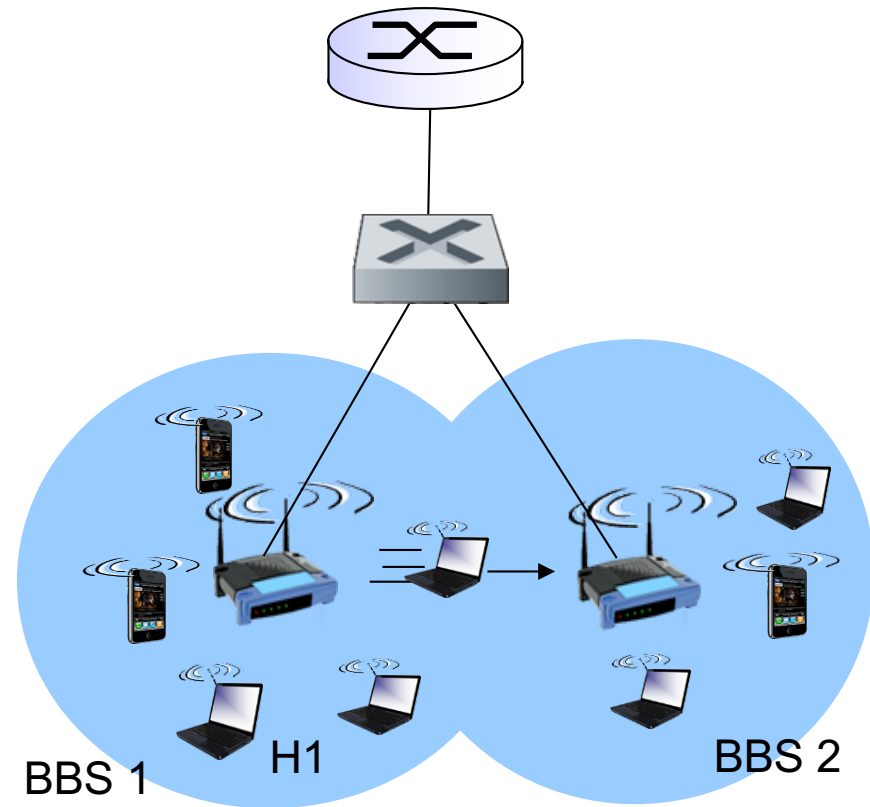

802.11: advanced capabilities

Rate adaptation

- base station, mobile dynamically change transmission rate (physical layer modulation technique) as mobile moves, SNR varies

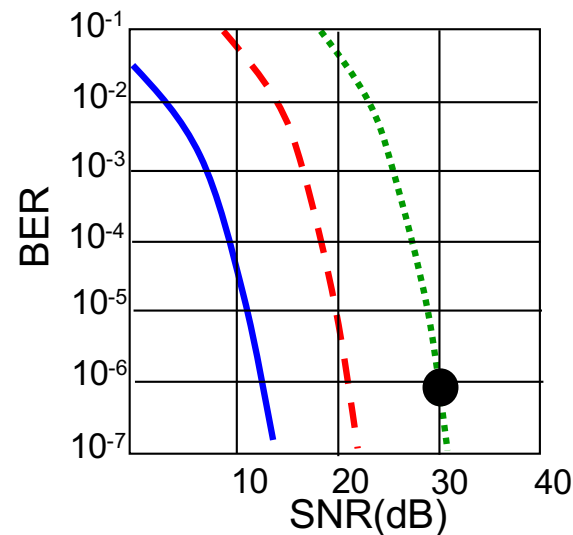
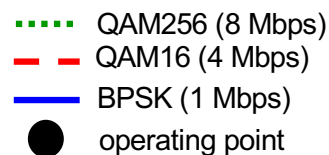

- SNR decreases, BER increase as node moves away from base station
- When BER becomes too high, switch to lower transmission rate but with lower BER

802.11: advanced capabilities

power management

- node-to-AP: “I am going to sleep until next beacon frame”
 - AP knows not to transmit frames to this node
 - node wakes up before next beacon frame
- beacon frame: contains list of mobiles with AP-to-mobile frames waiting to be sent
 - node will stay awake if AP-to-mobile frames to be sent; otherwise sleep again until next beacon frame

802.15: personal area network

- less than 10 m diameter
- replacement for cables (mouse, keyboard, headphones)
- ad hoc: no infrastructure
- master/slaves:
 - slaves request permission to send (to master)
 - master grants requests
- 802.15: evolved from Bluetooth specification
 - 2.4-2.5 GHz radio band
 - up to 721 kbps

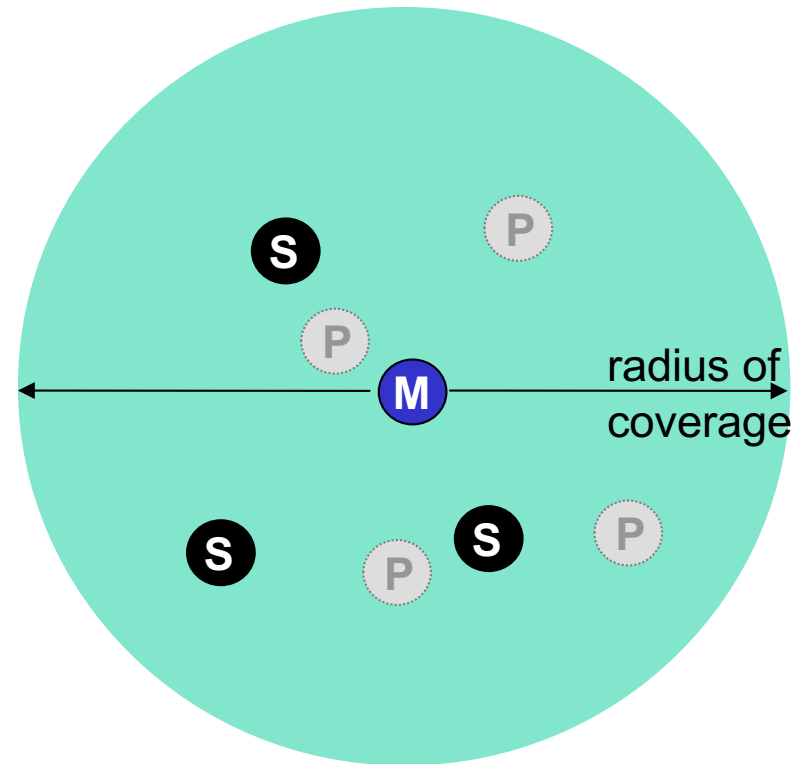

- M** Master device
- S** Slave device
- P** Parked device (inactive)